

COMMITTENTE



COMUNE DI NAPOLI

RESPONSABILE DEL PROCEDIMENTO
arch. Francesca Spera

CITTÀ VERTICALE: RIQUALIFICAZIONE DEI PERCORSI PEDONALI TRA LA COLLINA E IL MARE

PROGETTO ESECUTIVO / PEDAMENTINA



MANDATARIA



Via Pieveaiola, 15
06128 Perugia
info@sabeng.it www.sabsrl.eu

Arch. Pierpaolo Papi
Arch. Francesco Pecorari
Arch. Sergio Tucci
Arch. Francesco Fucelli
Arch. Luca Persichini
Ing. Marco Adriani
Ing. Vincenzo Pujia
Ing. Catuscia Maiggi
Ing. Barbara Bottausci
Dott.Agr. Maura Proietti

MANDANTI:



B5 S.r.l.
Via San'Anna dei Lombardi, 16
80134 - Napoli - info@b5srl.it
Società di Ingegneria
via San'Anna dei Lombardi 16
80134 Napoli
Tel. +39 081 551 83 83
Fax +39 081 551 83 83
E-mail: info@b5srl.it

Arch. Francesca Brancaccio Ph.D.
(Amministratore Unico e Direttore Tecnico)
Ing. Ugo Brancaccio
(Direttore tecnico)

Studio Ing. Alberto Capitanucci



ELABORATO

Relazione fotografica

| | | | |
|---------------------|----------|-----------------------|------------|
| N° ELAB. | NO. DOC. | COD. COMM. | CODE ORDER |
| 02.RRE001/00 | | CNAP.001-01-02.20.ESE | |
| | | SCALA | SCALE |
| | | | |

| | | | | |
|------|------------|-----------|--------|---------|
| 03 | | | | |
| 02 | | | | |
| 01 | | | | |
| 00 | ESECUTIVO | PECORARI | PAPI | ADRIANI |
| REV. | EMESSO PER | ISSUED TO | RED. | COMP. |
| | | | CONTR. | DATA |
| | | | APPR. | DATE |

SCALA PEDAMENTINA

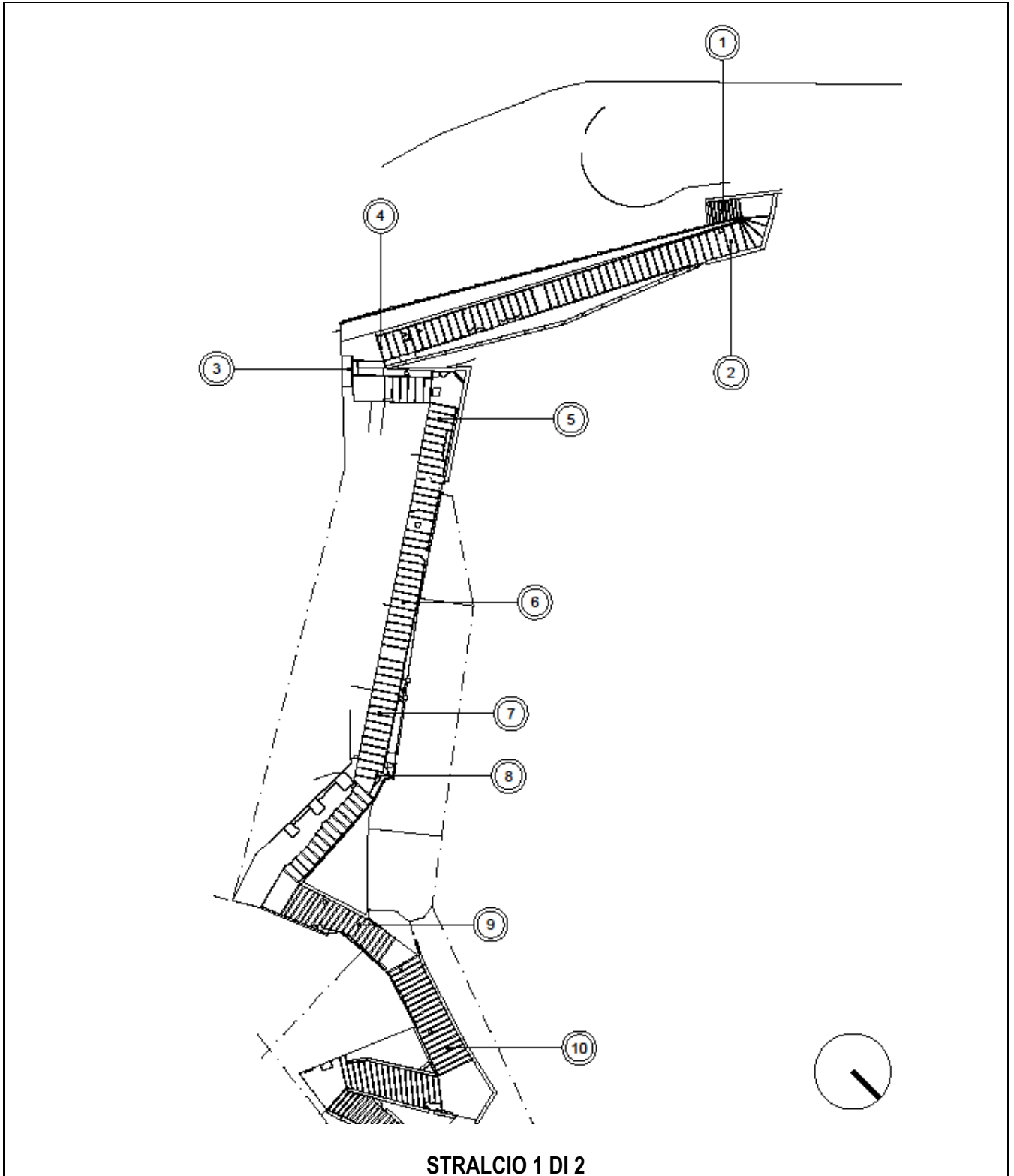

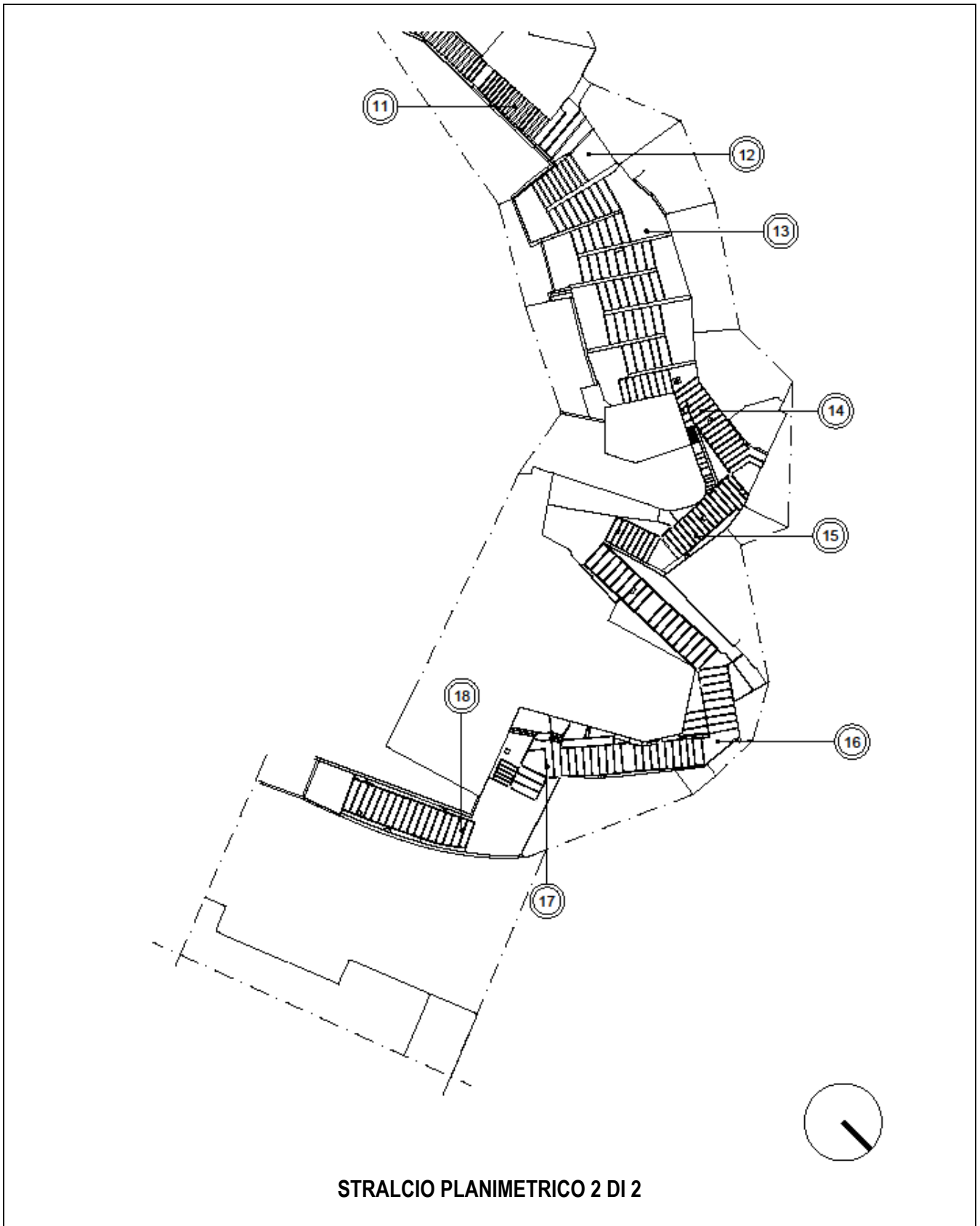

STRALCIO PLANIMETRICO 2 DI 2



1



2



3



4

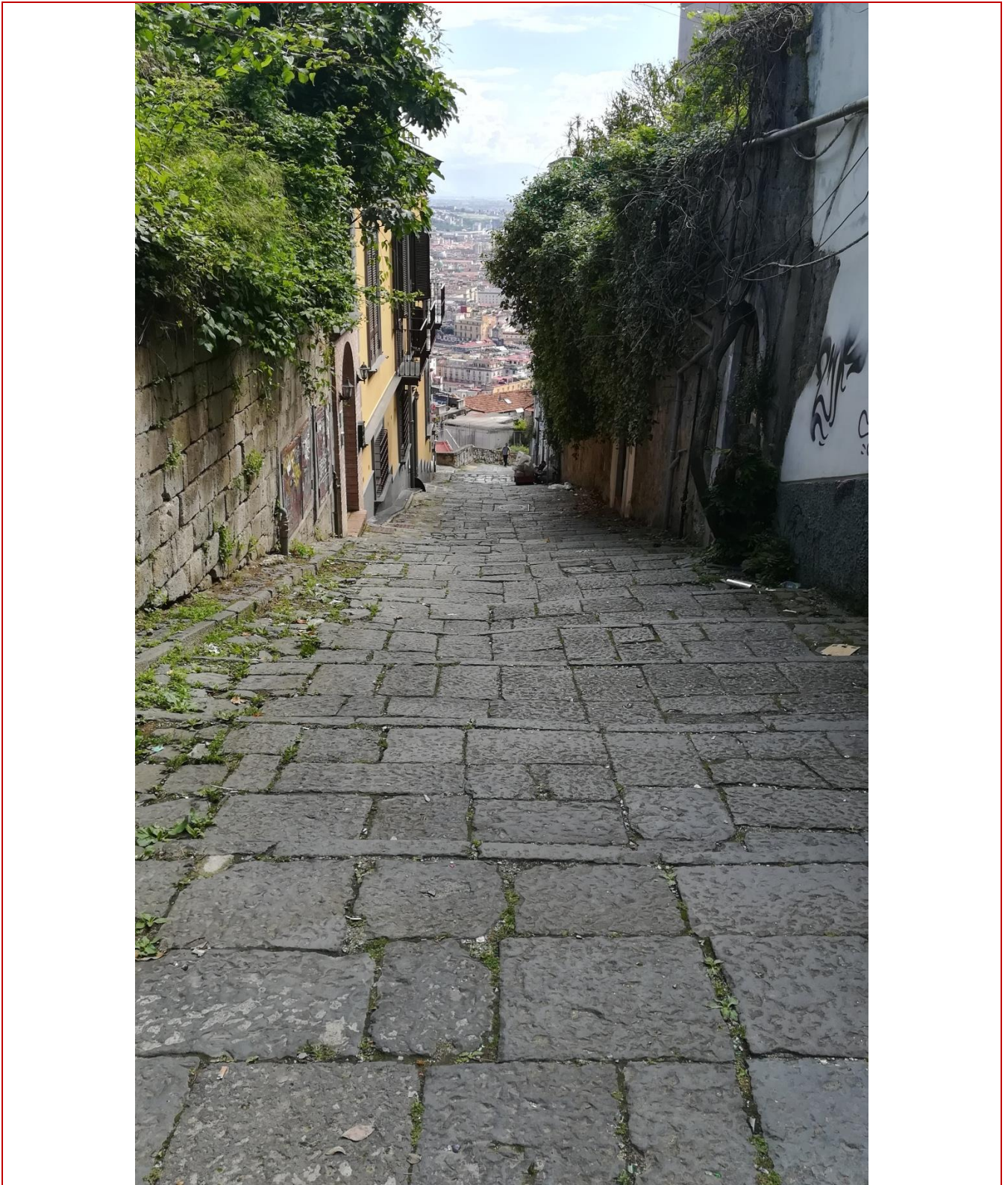



6



7

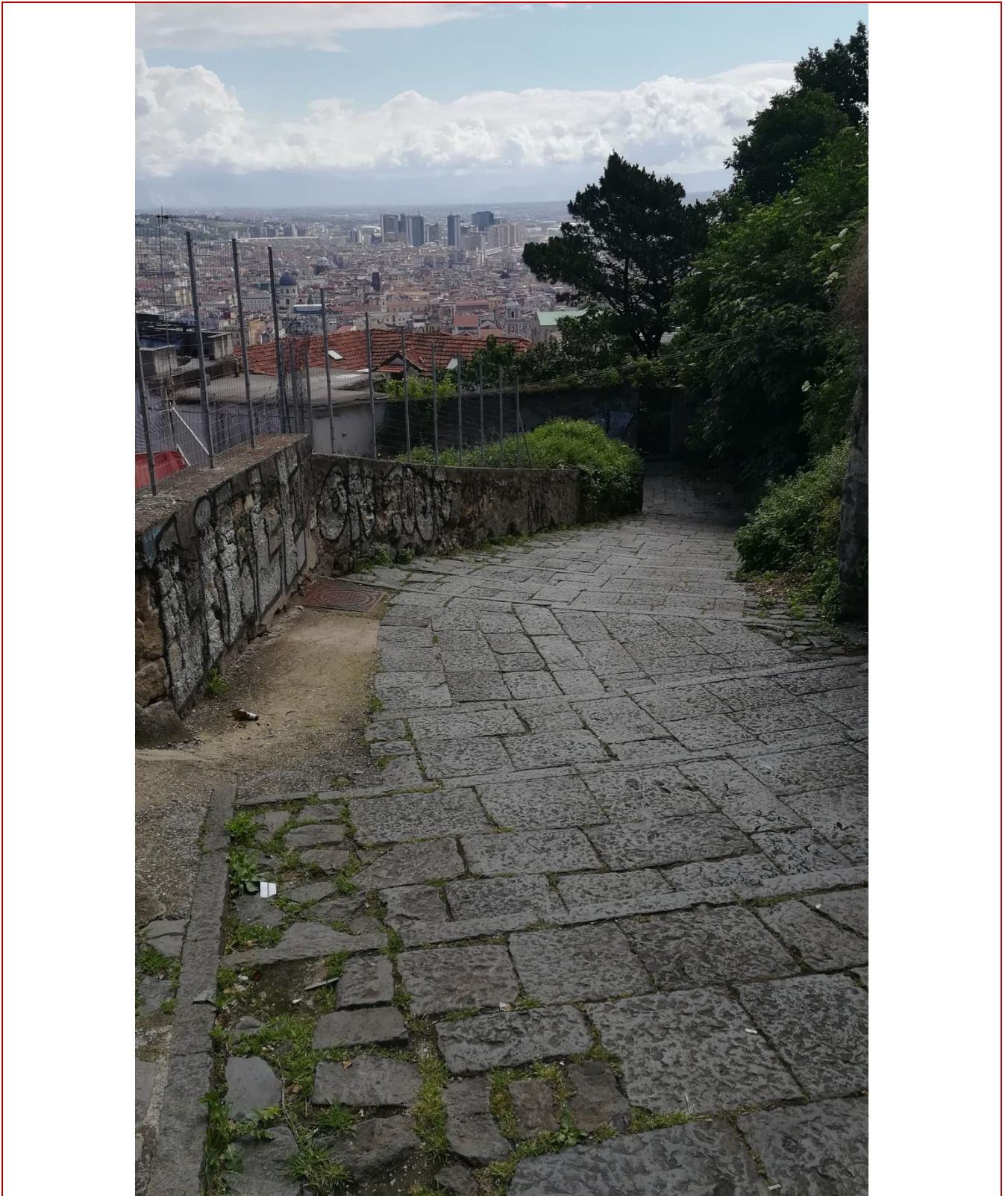



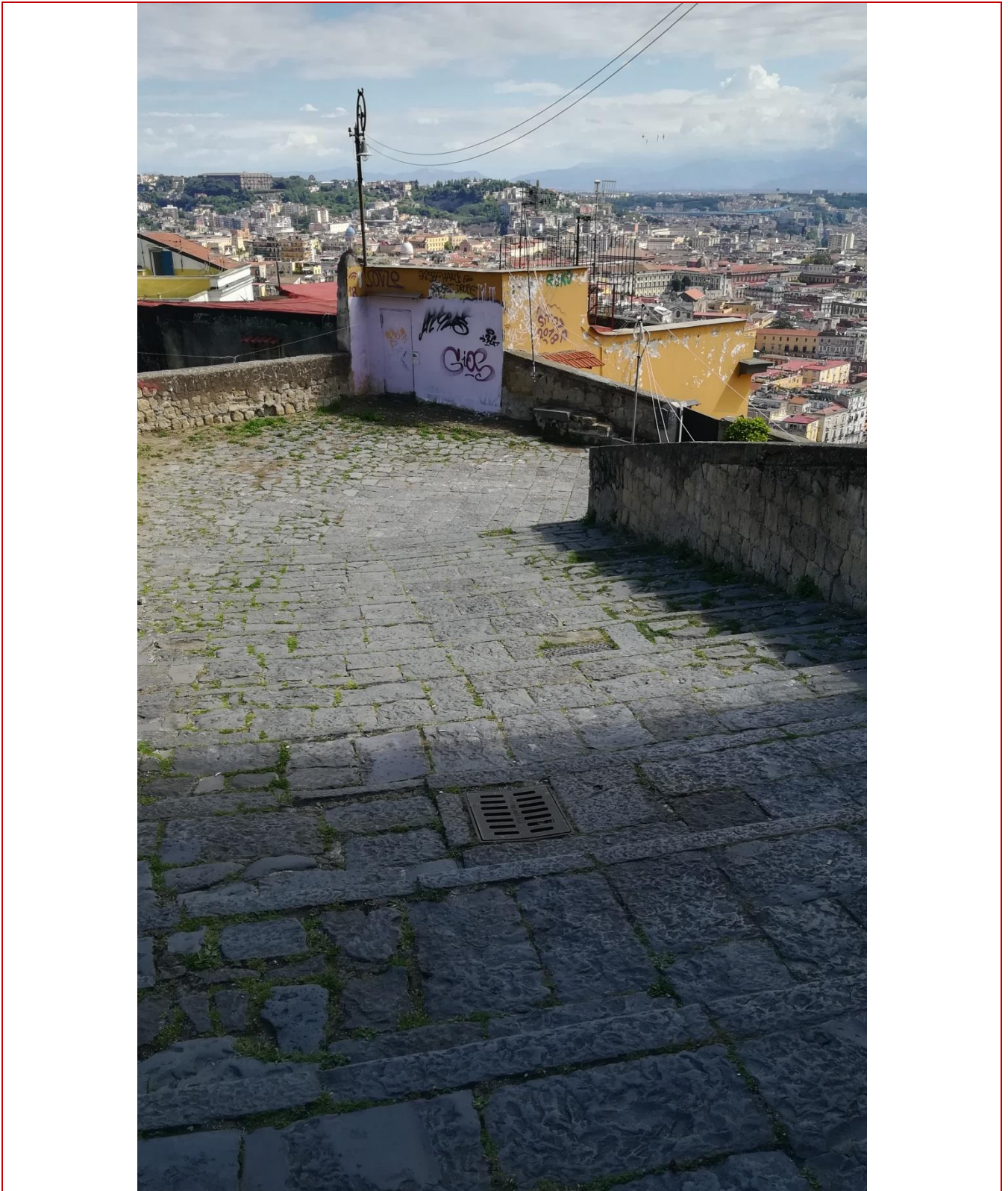



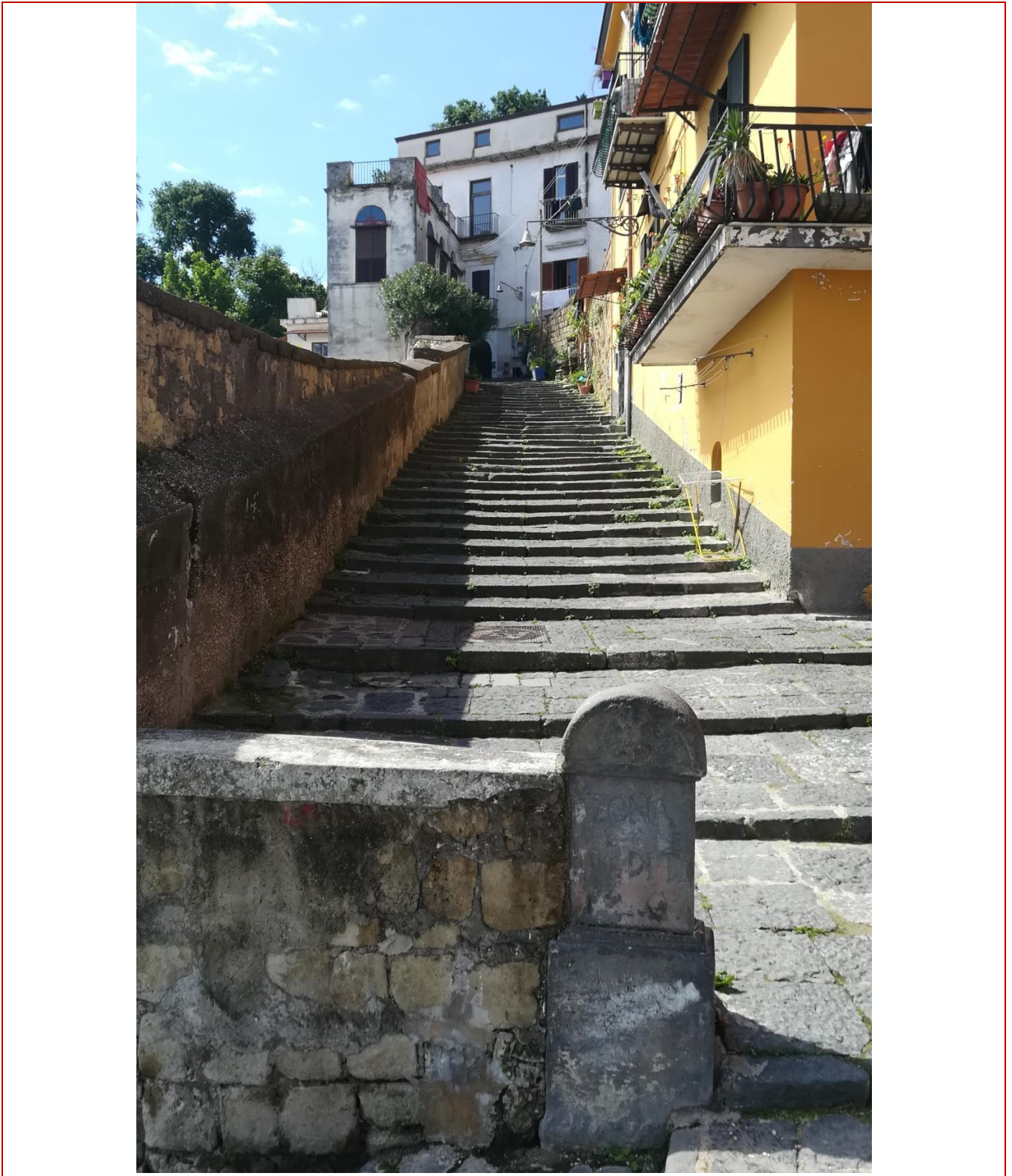



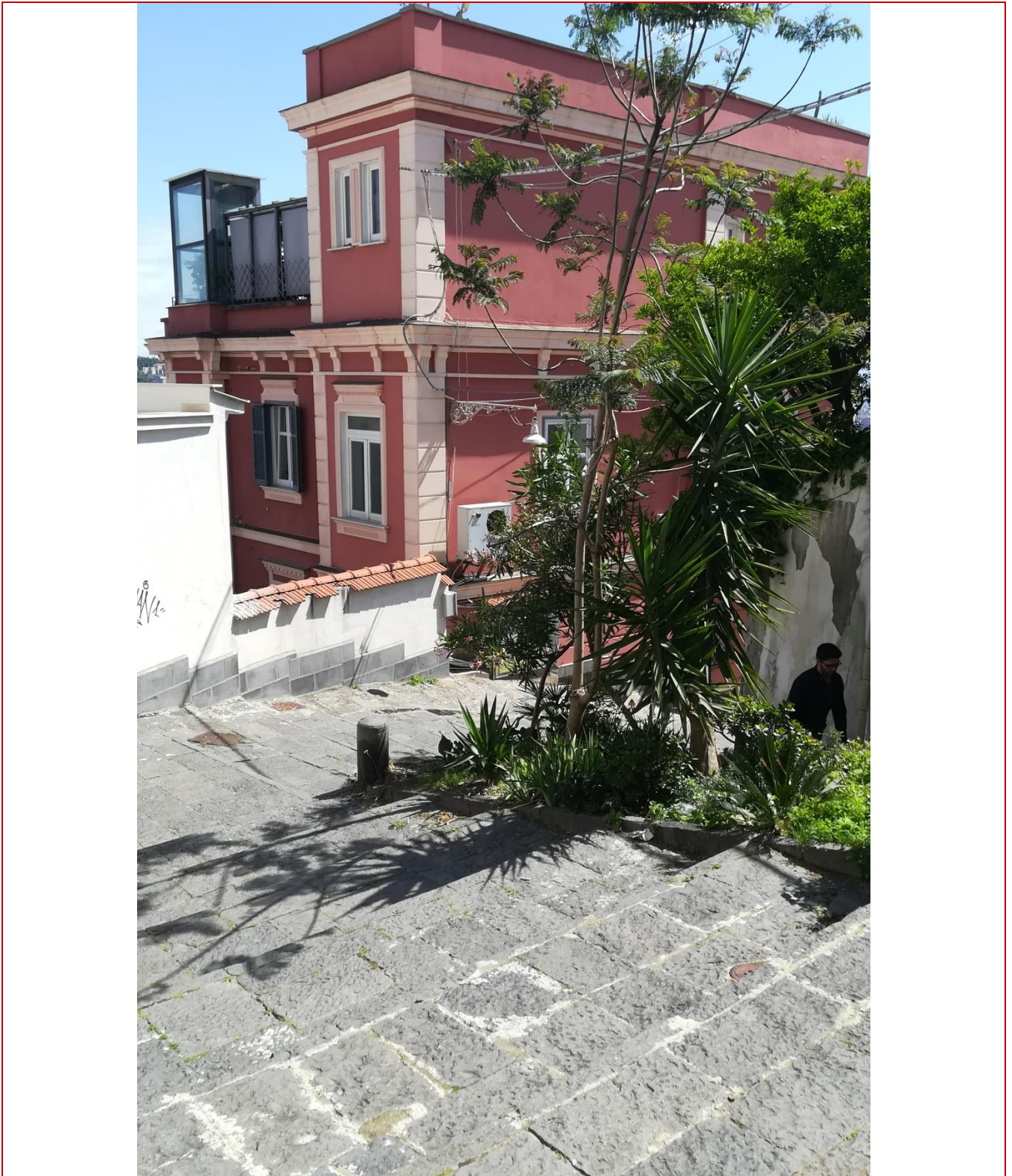

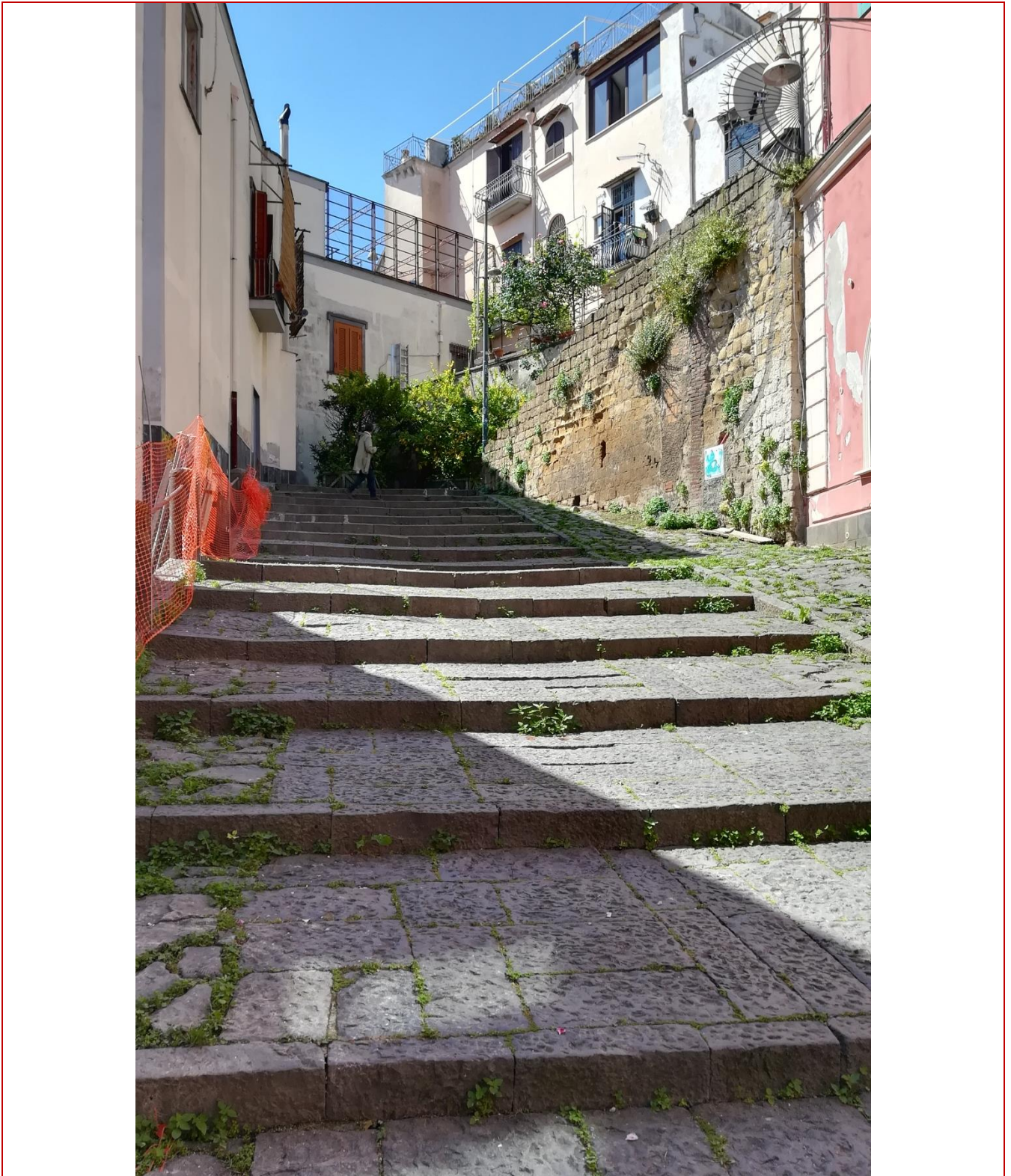





17



18